

C A H I E R D E S C H A R G E S
A C C O R D - C A D R E A C Q U I S I T I O N H A B I T A T S
M O D U L A I R E S / L E G E R S T R A N S P O R T A B L E S E T
D E P L A Ç A B L E S

TELLURIA PRODUCTS

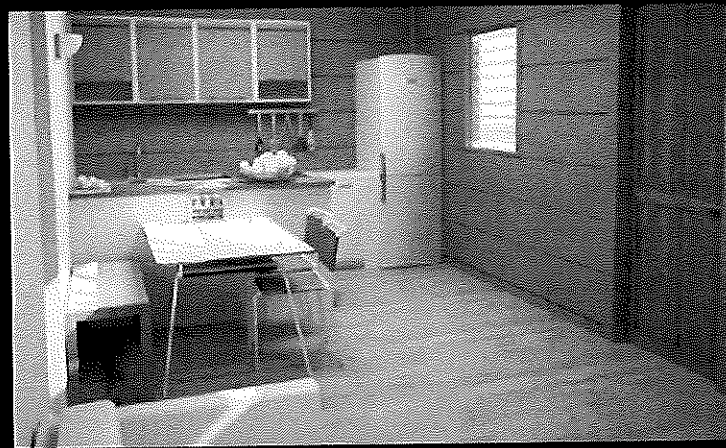
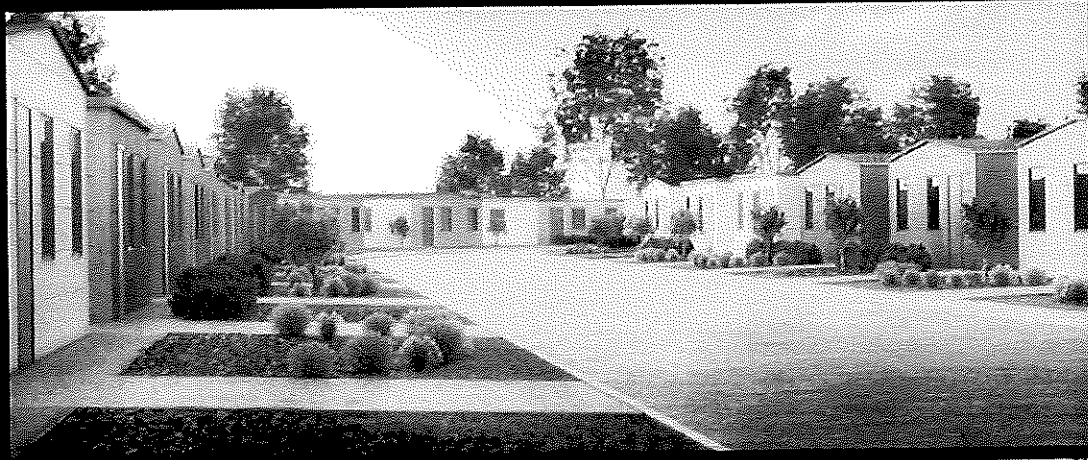

ANNEXE 4 : Documents nécessaires au critère 3

A. Les documents graphiques (disposition 2 chambres) Telluria ELEGANTO 7478

L'offre est modulaire. Nous avons choisi d'illustrer un module 2 chambres mais l'offre est identique au niveau de la surface extérieure (60 m²) en 1 et 2 chambres. L'espace des autres pièces de vie est adapté en cas de suppression d'1 chambre.

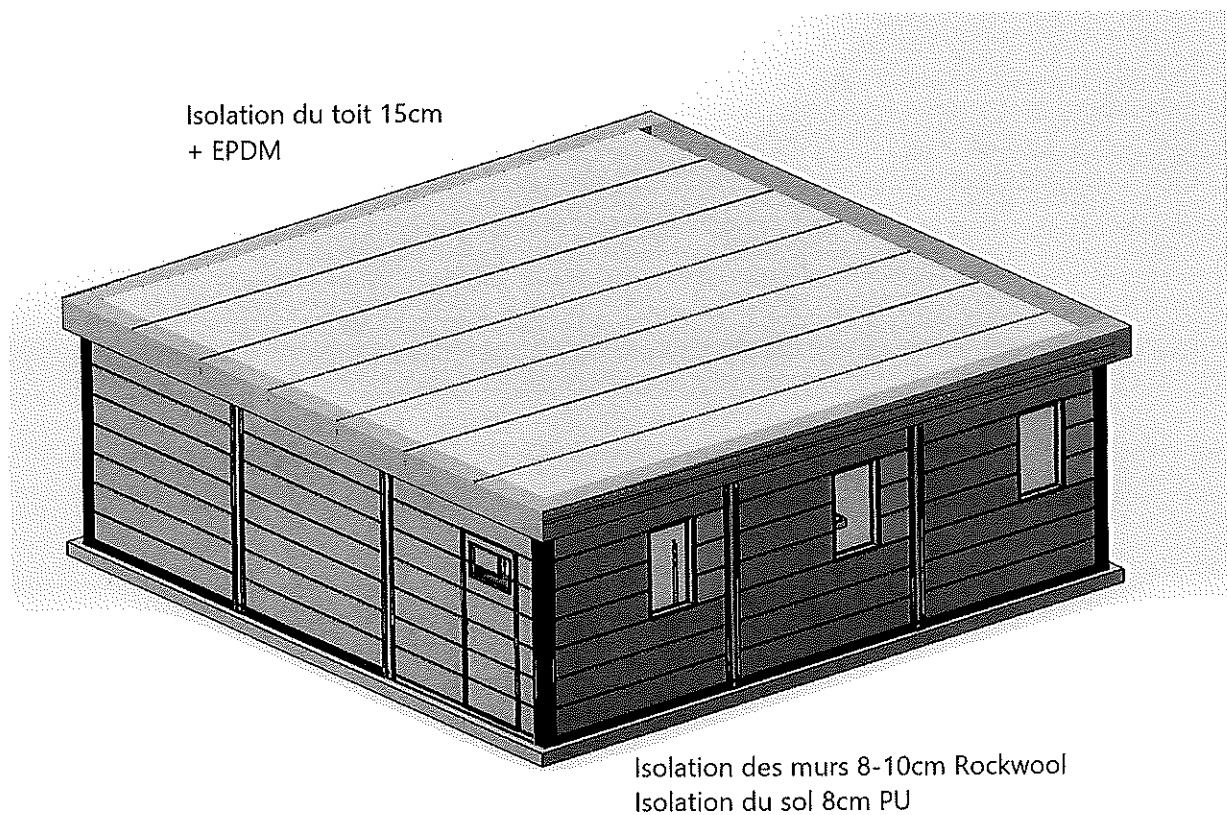

C A H I E R D E S C H A R G E S
A C C O R D - C A D R E A C Q U I S I T I O N H A B I T A T S
M O D U L A I R E S / L E G E R S T R A N S P O R T A B L E S E T
D E P L A Ç A B L E S

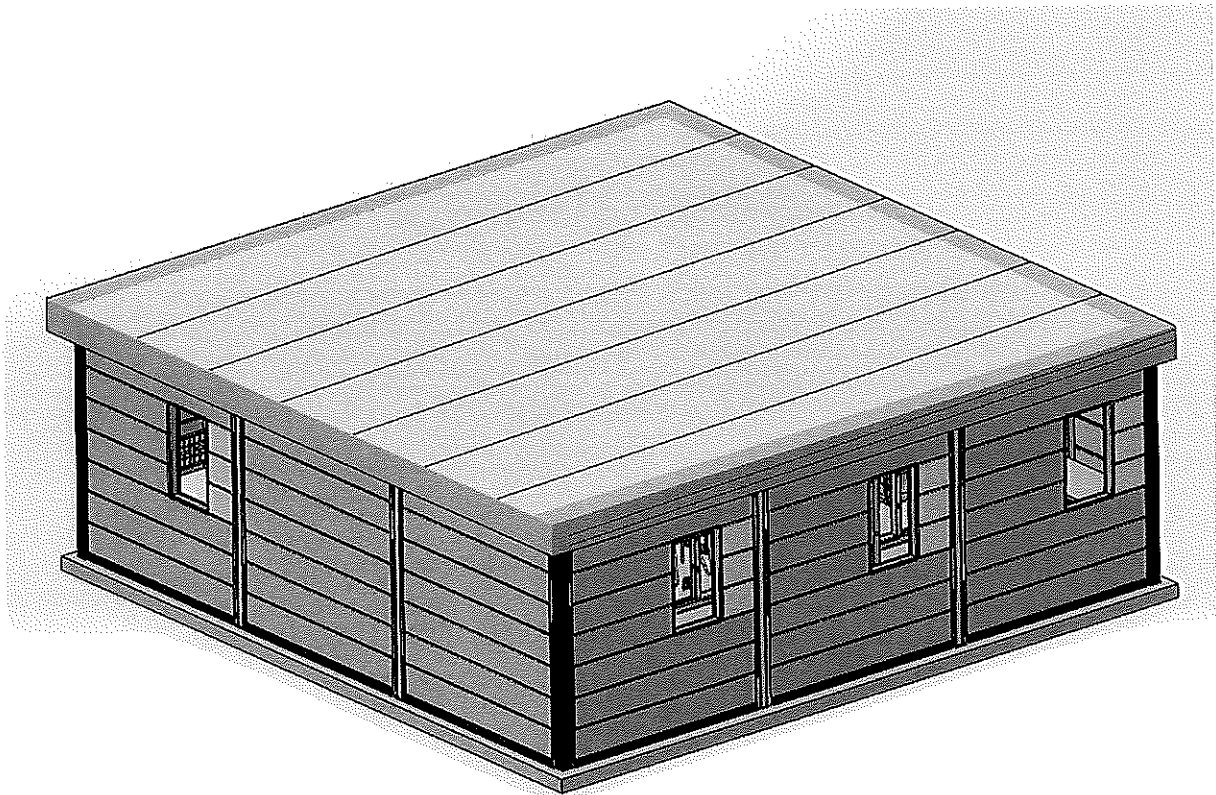

C A H I E R D E S C H A R G E S
A C C O R D - C A D R E A C Q U I S I T I O N H A B I T A T S
M O D U L A I R E S / L E G E R S T R A N S P O R T A B L E S E T
D E P L A Ç A B L E S

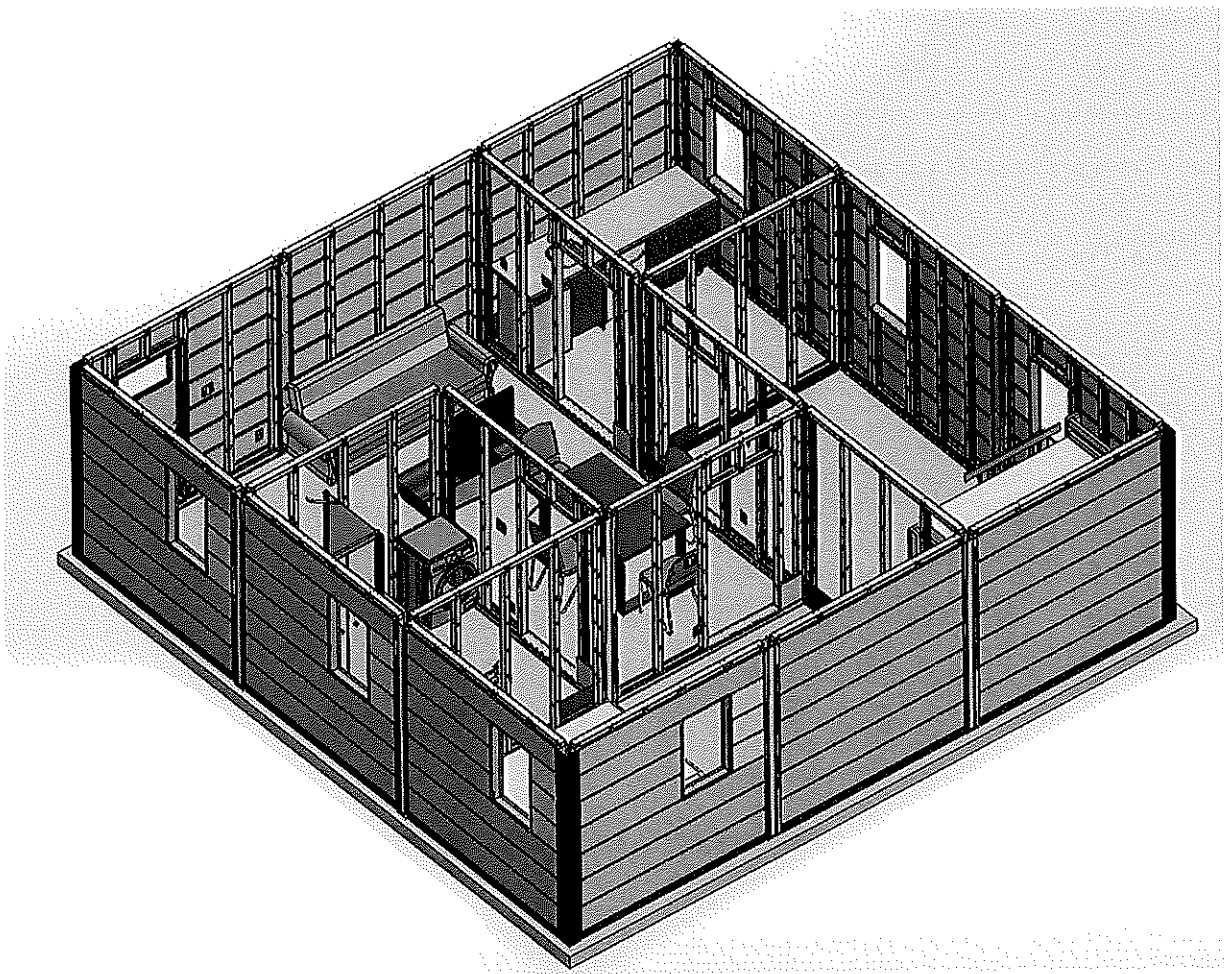

C A H I E R D E S C H A R G E S
A C C O R D - C A D R E A C Q U I S I T I O N H A B I T A T S
M O D U L A I R E S / L E G E R S T R A N S P O R T A B L E S E T
D E P L A Ç A B L E S

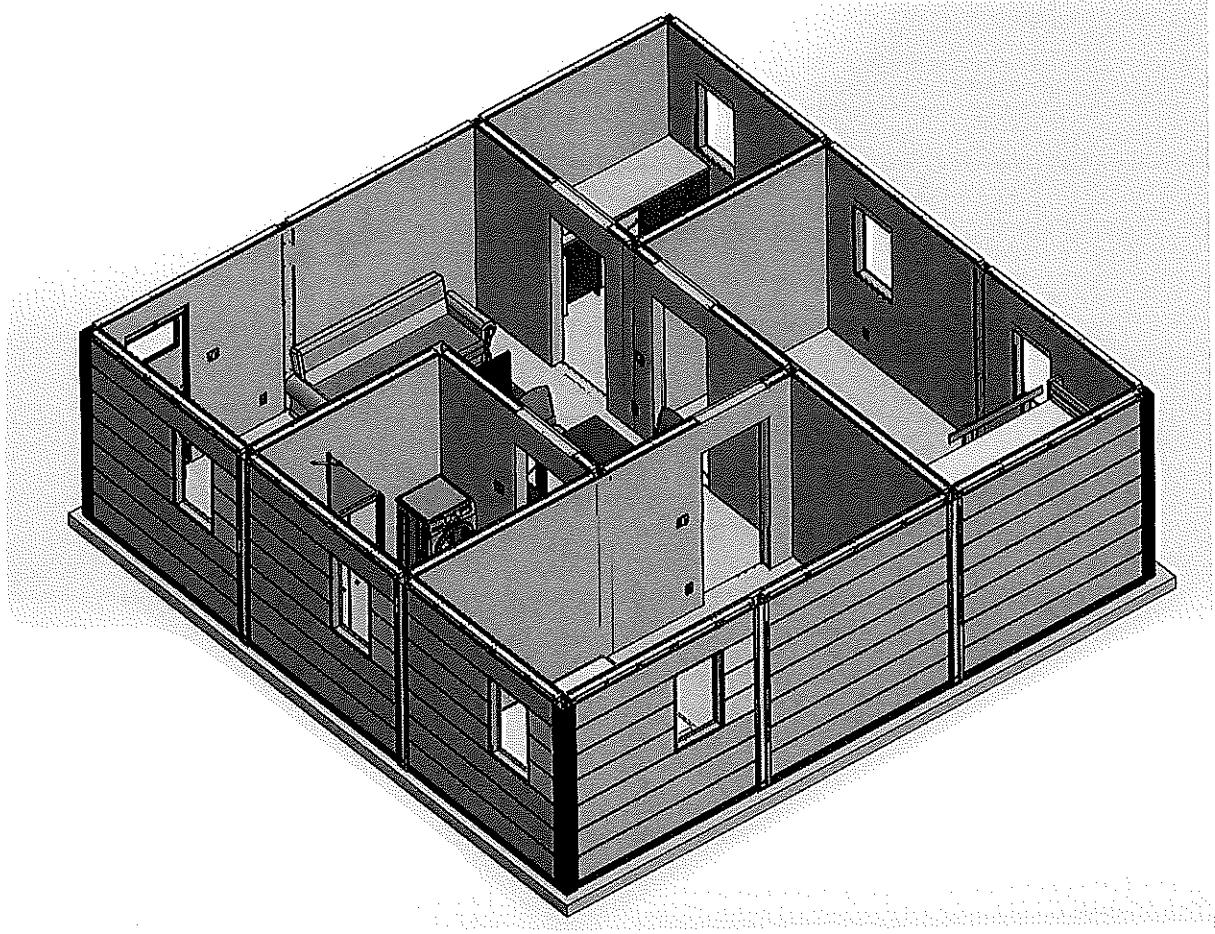

C A H I E R D E S C H A R G E S
A C C O R D - C A D R E A C Q U I S I T I O N H A B I T A T S
M O D U L A I R E S / L E G E R S T R A N S P O R T A B L E S E T
D E P L A Ç A B L E S

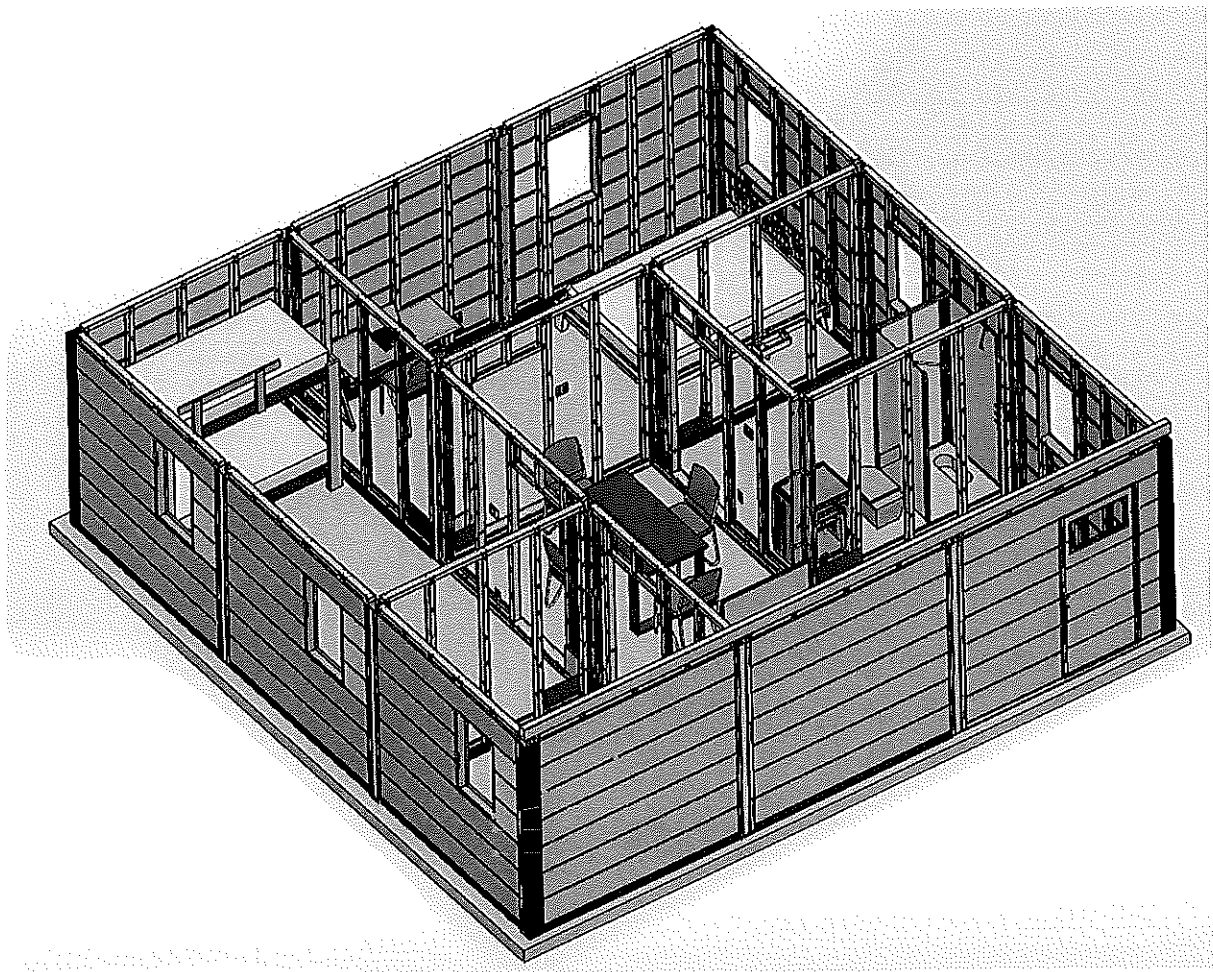

C A H I E R D E S C H A R G E S
A C C O R D - C A D R E A C Q U I S I T I O N H A B I T A T S
M O D U L A I R E S / L E G E R S T R A N S P O R T A B L E S E T
D E P L A Ç A B L E S

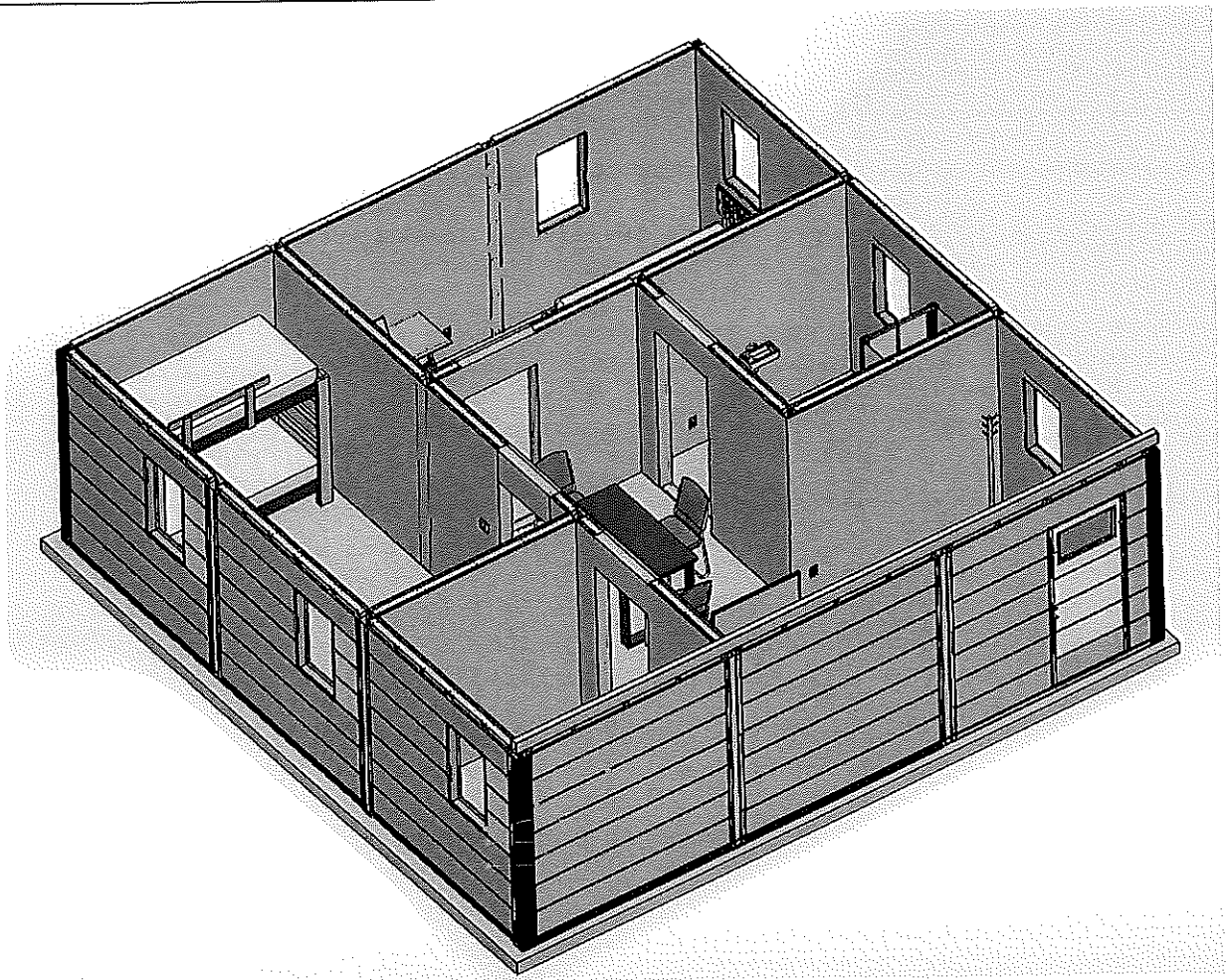

C A H I E R D E S C H A R G E S
A C C O R D - C A D R E A C Q U I S I T I O N H A B I T A T S
M O D U L A I R E S / L E G E R S T R A N S P O R T A B L E S E T
D E P L A Ç A B L E S

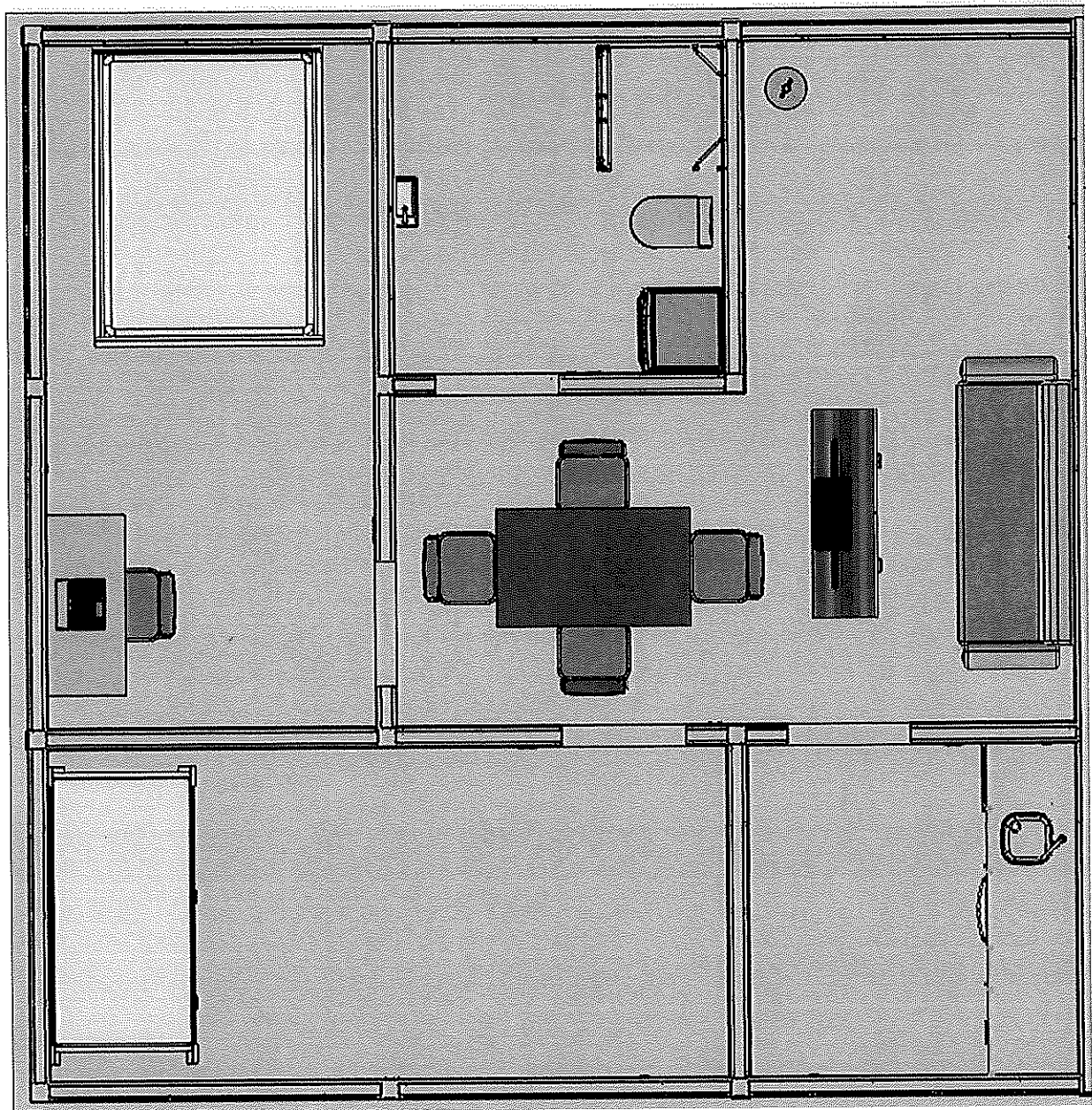

WOOD EXIBEL

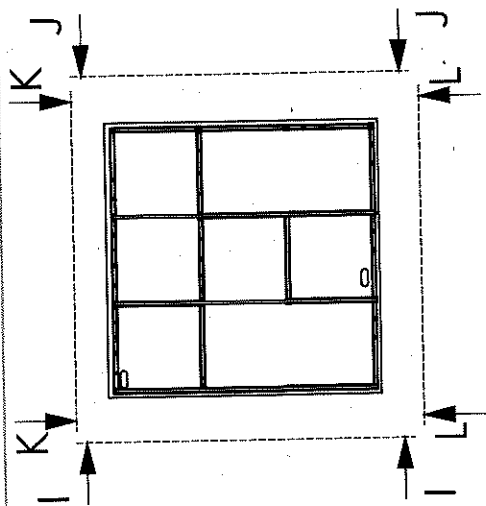

SECTION K-K
SCALE 1 : 75

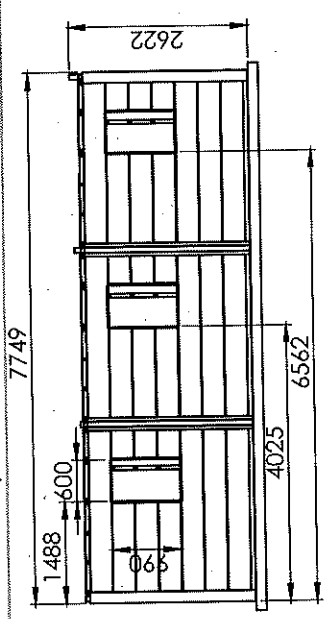

SECTION J-J
SCALE 1 : 75

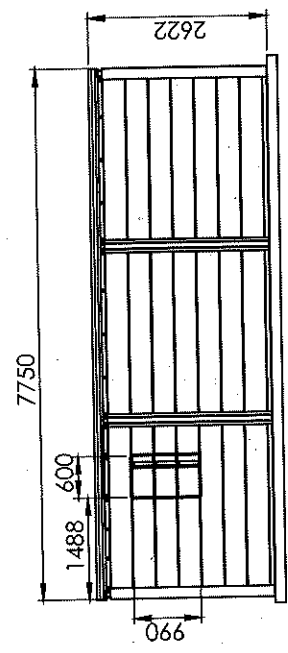

SECTION H
SCALE 1 : 75

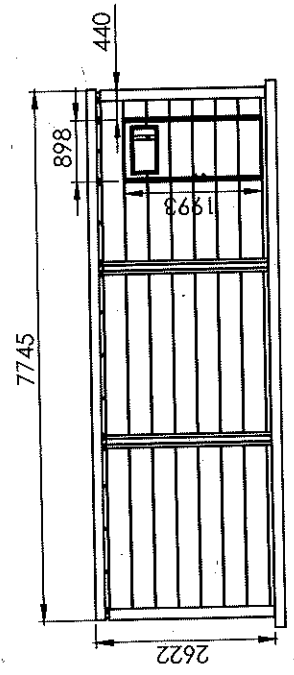

SECTION L-L
SCALE 1 : 75

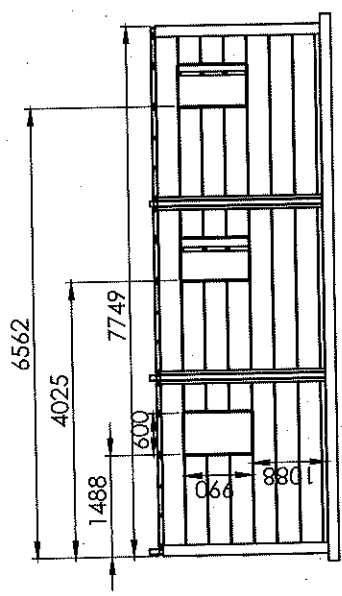

SUIV INDICATION CONTINUA: UNITS EN MILLIMETRES ET DE ESPACES: TOLERANCES: LINEAIRES: ANGULAIRES:		NOM MONT/LIC.		SIGNATURE	DATE	CASER LES ANGLES VES		NE PAS CHANGER L'ECHELLE	REVISION
AUTEUR	VERIF.	APPR.	FAB.	QUAL.	MATERIAU:	TITRE		No. DE PLAN	
					Echelle: 1/100				
					feuille 1 sur 1				
					A3				



Detail
1/2.5

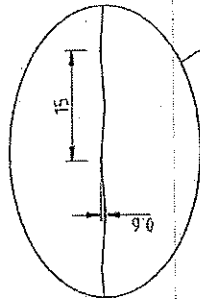
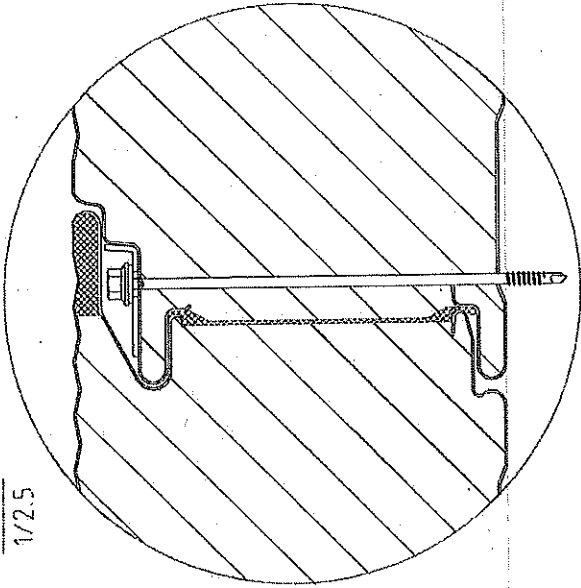

1000

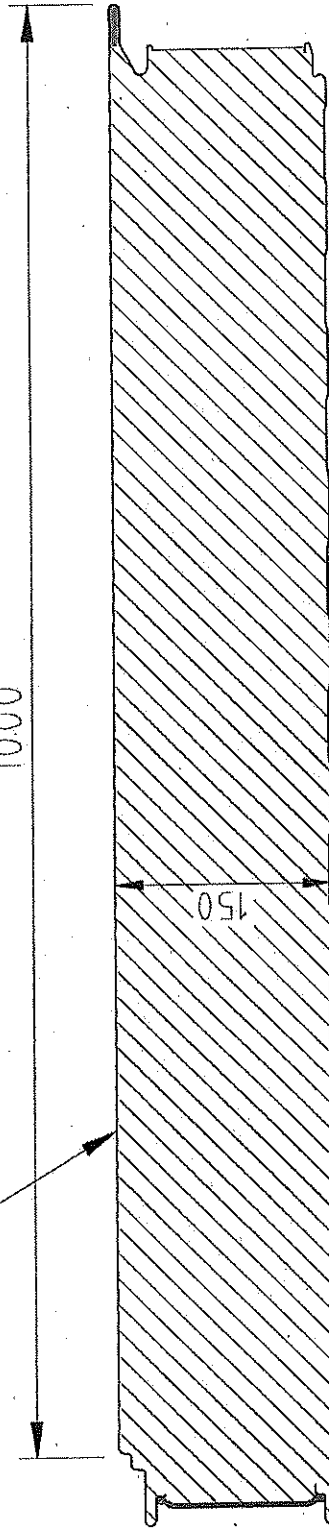

Scale 1:5		
Design JD	Nr. J1216	Rev.
Approval: JF		D
Update: 05.08.2019		
J1 WALL 1000SF 150 PIR		

JORISIDE
THE STEEL FUTURE

JORISIDE nv www.joriside.be
Hille 174, 8750 Zwevezele, Belgium
Tel: 0032 (0)51612871 Fax: 0032 (0)51612700

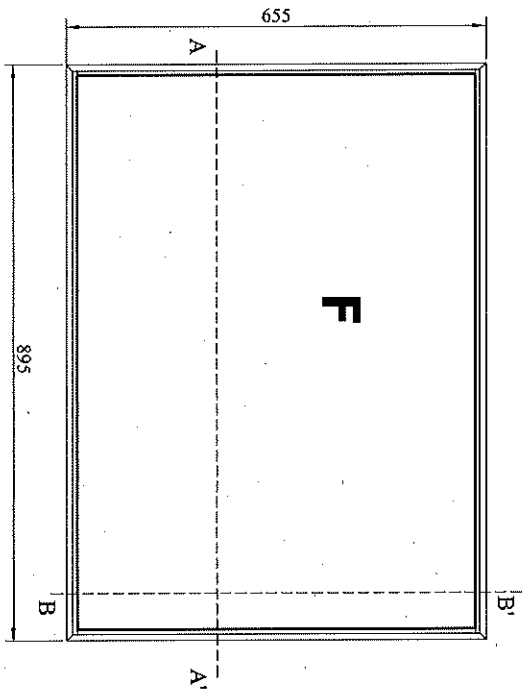

A-A'

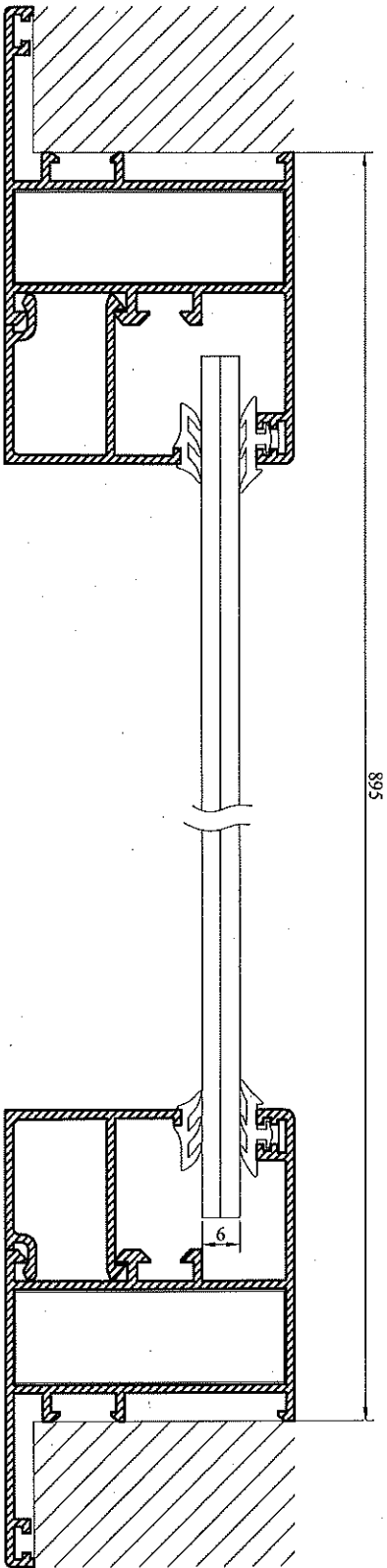

895

B-B'

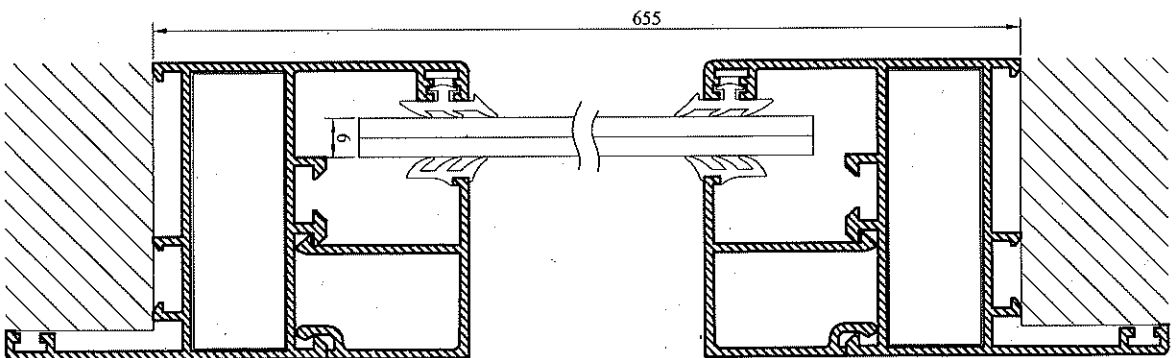

655

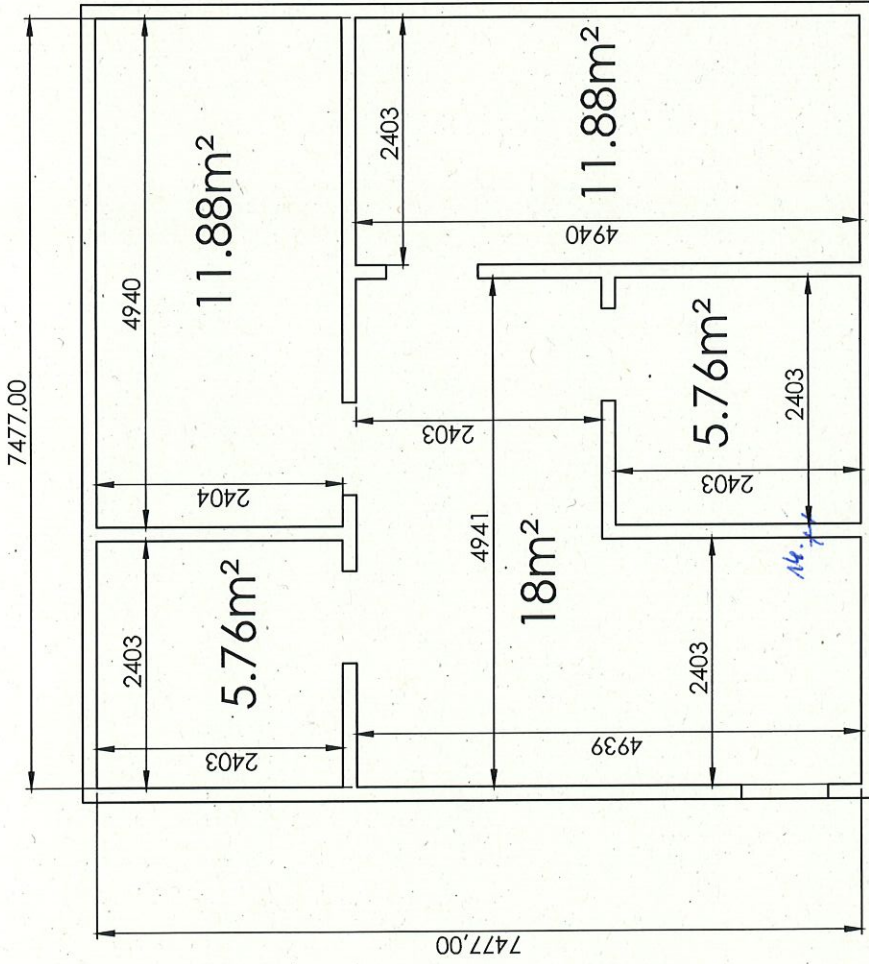

SAUF INDICATION CONTRAIRE:
LES COTES SONT EN MILLIMETRES
ETAT DE SURFACE
TOLERANCES
ANGULAIRES



CASER LES
ANGLES VFS

NE PAS CHANGER L'ECHELLE

REVISION

NOM	SIGNATURE	DATE
AUTEUR		
VERIF.		
APPR.		
FAB.		
QUAL.		

MATRIALUG.	MATERIAU:	MASS:

TITRE:

N° DE PLAN

A3

ECHELLE: 1:100

FEUILLE 1 SUR 1